

Article number: 201581M1670PLE

Description: E+G Screw GN 1581-M16-70-PL-E  
EPDM Sealing ring in hygienic design

## Measures

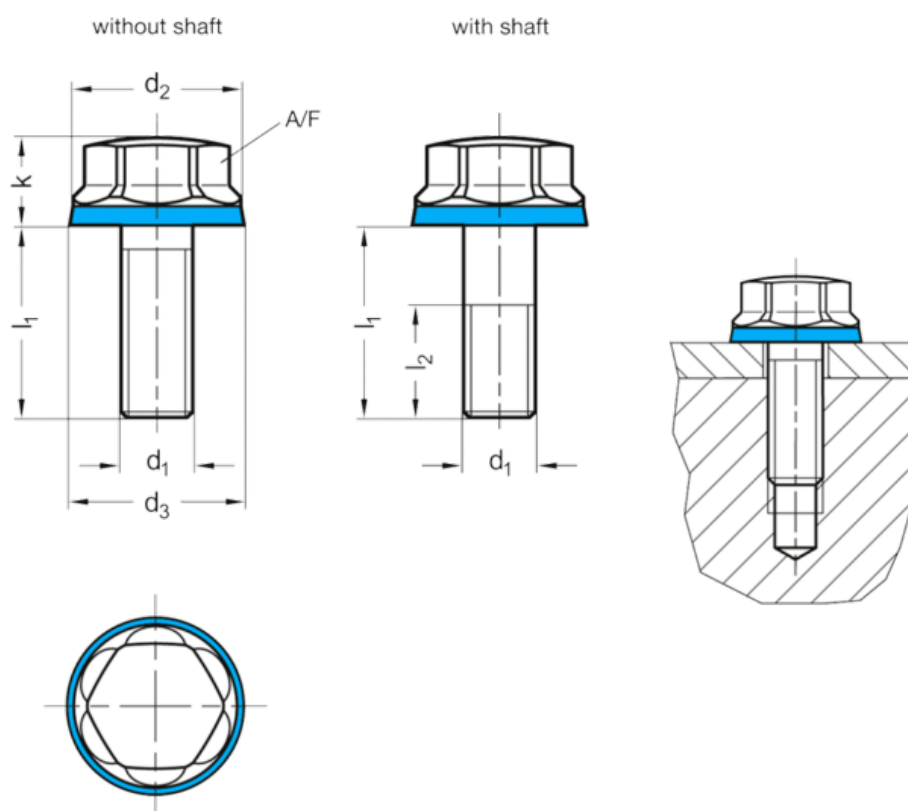

A/F	= 22	Weight in (g) = 153
d1	= M16	
d2	= 28	
d3	= 28.8	
l1 without shaft	= -	
l1 with shaft	= 70	
l2	= 22	
k	= 13	